



GROUND CONTROL® 3.0
TROUBLESHOOTING GUIDE

L I P P E R T
C O M P O N E N T S®

TABLE OF CONTENTS

System and Safety Information	2
Prior To Operation	3
Touch Pad Diagram	3
Operation	4
Basic Jack Operation.....	4
Unhitching From A Tow Vehicle.....	4
Auto Level.....	5
Auto Level Sequence.....	5
Hitch Recognition.....	5
System Settings	6
Homing Jacks.....	6
Zero Point Calibration.....	6
Troubleshooting	7
Manual Override.....	7
Touch Pad Error Codes.....	8
Special Jack Error Codes.....	9
Wiring Diagram - 4 Point	10
Wiring Diagram - 6 Point	11
GROUND CONTROL® 3.0 4 POINT ASSEMBLY	12
GROUND CONTROL® 3.0 6 POINT ASSEMBLY	13
GROUND CONTROL® 3.0 4 POINT AFTERMARKET ASSEMBLY	14
GROUND CONTROL® 3.0 6 POINT AFTERMARKET ASSEMBLY	15
GROUND CONTROL® 3.0 COMPONENTS	16-19

System and Safety Information

WARNING

Failure to act in accordance with the following may result in death or serious personal injury. The use of the Ground Control® 3.0 leveling system to support the trailer for any reason other than which it is intended is prohibited by Lippert's limited warranty. The Lippert leveling system is designed as a "leveling" system only and should not be used to provide service for any reason under the trailer such as changing tires or servicing the leveling system. Any attempts to change tires or perform other service while trailer is supported by the Ground Control 3.0 leveling system could result in damage to the 5th wheel and/or cause death or serious injury.

CAUTION

Moving parts can pinch, crush or cut. Keep clear and use caution.

Prior to Operation

The leveling system should only be operated under the following conditions:

1. The trailer is parked on a reasonably level surface.
2. Be sure all persons, pets, and property are clear of the trailer while the leveling system is in operation.
3. Make sure battery(ies) are fully charged and test at 12+VDC under load.

Touch Pad Diagram

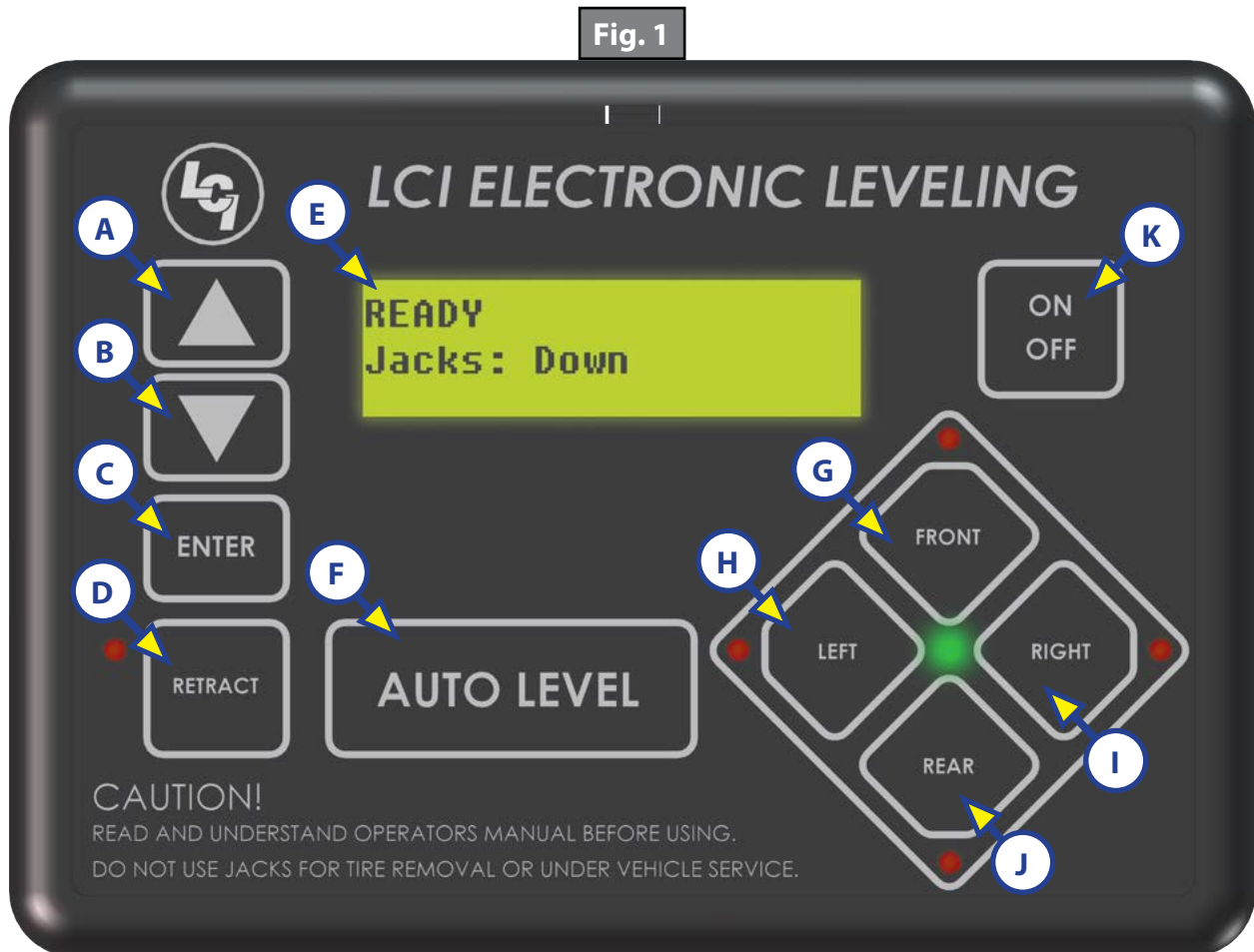

Callout	Description
A	Up Arrow - Scrolls up through the menu on LCD.
B	Down Arrow - Scrolls down through the menu on LCD.
C	Enter - Activates modes and procedures indicated on LCD.
D	Retract - Places leveling system into retract mode. Press and hold down for 1 second to initiate Auto Retract.
E	LCD Display - Displays procedures and results.
F	Auto Level - Places leveling system into auto level mode.
G	Front Jack Button - Activates front jacks in manual mode.
H	Left Jack Button - Activates left jacks in manual mode.
I	Right Jack Button - Activates right jacks in manual mode.
J	Rear Jack Button - Activates rear jacks in manual mode.
K	Power Button - Turns leveling system on and off.

Operation

⚠️ WARNING

Be sure to park the trailer on solid, level ground. Clear all jack landing locations of debris and obstructions. Locations should also be free of depressions. When parking the trailer on extremely soft surfaces, utilize load distribution pads under each jack. People and pets should be clear of trailer while operating leveling system. Never lift the trailer completely off the ground. Lifting the trailer so the wheels are not touching the ground will create an unstable and unsafe condition.

Basic Jack Operation

Landing gear (front jacks) can be operated any time the system is "ON." By pushing the "FRONT" button (Fig. 1G), both front jacks can be extended. By pushing either the "FRONT" and "LEFT" (Fig. 1H) or "FRONT" and "RIGHT" (Fig. 1I) buttons, the individual front jacks can be extended. If the touch pad is put in the retract mode, indicated by the orange illuminated LED next to the "RETRACT" button (Fig. 1D), the front jacks can be retracted together by pushing the "FRONT" button (Fig. 1G) or individually by pressing "LEFT" (Fig. 1H) or "RIGHT" (Fig. 1I) buttons, while simultaneously pressing the "FRONT" button (Fig. 1G).

Middle jacks, if equipped, can not be extended or retracted in standard mode or manual mode. Middle jacks can only be operated in the special jack code error mode. In order to operate the middle jacks press "LEFT" (FIG. 1H) and "RIGHT" (FIG. 1I) buttons simultaneously.

The rear jacks can only be extended when the touch pad is in the manual mode. Once system is in manual mode, pressing the "REAR" button (Fig. 1J) will extend both rear jacks at the same time. To extend individual rear jacks, press the "LEFT" (Fig. 1H) or "RIGHT" (Fig. 1I) buttons while simultaneously pressing the "REAR" button (Fig. 1J), depending on which jack needs to be operated. If the touch pad is put in the retract mode, indicated by the orange illuminated LED next to the "RETRACT" button (Fig. 1D), the rear jacks can be retracted together by pushing the "REAR" button (Fig. 1J) or individually by pressing either the "LEFT" (Fig. 1H) or "RIGHT" (Fig. 1I) buttons, while simultaneously pressing the "REAR" button (Fig. 1J).

NOTE: If the rear jacks will not operate individually using the method described above, but they operate properly when Auto Level is performed, the Twist Prevention Protection system has locked out the operation to prevent damage to the frame of the trailer.

Unhitching From A Tow Vehicle

NOTE: Prior to unhitching from the tow vehicle, ensure the trailer is parked on a level surface and be sure to chock the tires of the trailer.

1. Extend the inner legs of both landing gear (front jacks) to within 4-5" of the ground by pulling on the quick-release pins.
2. Push "ON/OFF" (Fig. 1K). LCD Screen will light up and display "READY JACKS: UP" (Fig. 2A).
3. Push the "UP" arrow (Fig. 1A) to scroll to "Drop Front Jacks" option on LCD screen.
4. Red indicator lights (Fig. 2B) may come on, indicating the current disposition of the trailer. In this case, the front and right sides of the trailer are low.
5. Push "ENTER" (Fig. 1C). Both front jacks will go to ground and stop.
6. Push the "FRONT" button (Fig. 1G) extending the front jacks to a sufficient height, which raises the front of the trailer off of the tow vehicle's 5th wheel hitch plate.
7. Pull tow vehicle away and park at a safe distance.

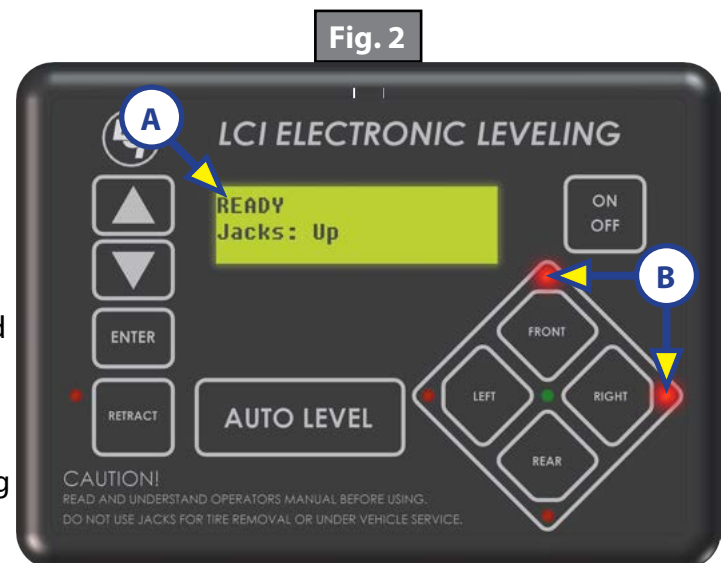

Auto Level

1. After unhitching from tow vehicle and parking the vehicle at a safe distance away from the trailer, press the "ON/OFF" button (Fig. 1K) and then press "AUTO LEVEL" (Fig. 1F).

NOTE: Once the automatic leveling cycle has been started, it is important that there is no movement in the trailer until the trailer has completed the leveling process. Failure to remain still during the leveling cycle could have an effect on the performance of the leveling system.

NOTE: In order for hitch recognition feature to function, the auto level sequence must be started with the front of the trailer above level.

Auto Level Sequence

1. When Auto Level Sequence begins, the front of the trailer will lower slightly to a point below level.
2. Rear jacks will be grounded.
3. A side-to-side leveling sequence occurs.

NOTE: At this point on the 6 Point System, the 2 middle jacks are grounded to stabilize the trailer. These 2 jacks do not level the trailer.

4. Each jack will perform a final grounding touch.
5. LCD will read "AUTO LEVEL SUCCESS" (Fig. 3A).
6. LCD will then read "READY Jacks: Down" (Fig. 4A), and the green LED at the center of the 4 jack buttons will be illuminated (Fig. 4B).

NOTE: If the AUTO LEVEL sequence does not perform as described, place the system in manual mode and test that the jacks operate correctly by pushing their coordinating buttons on the touch pad; i.e. "FRONT" button operates only the front jacks, etc.

Fig. 3



Fig. 4

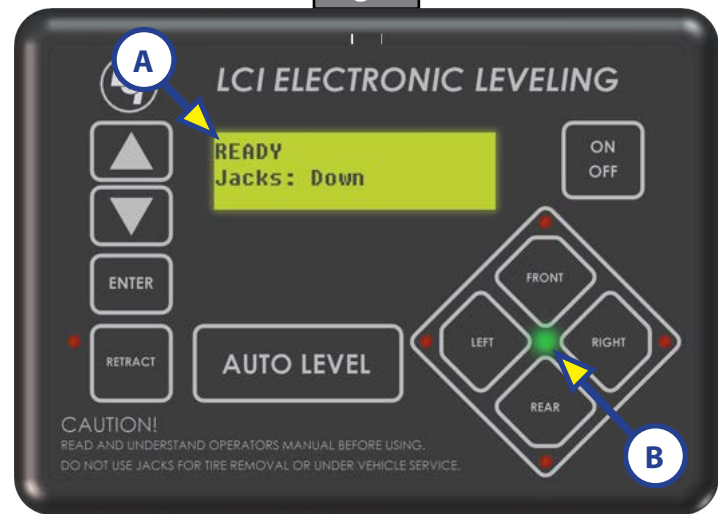

Hitch Recognition

1. Turn on the touch pad.
2. Push the "UP" arrow (Fig. 1A) to scroll to "Auto Reconnect" option on LCD screen.
3. Push "ENTER" (Fig. 1C). The rear jacks and middle jacks (if equipped) will retract first, then the front jacks will extend to raise the trailer to the height where the auto level sequence was started.

NOTE: If the auto level sequence was started with the front of the trailer in a below-level condition, the Hitch Recognition will not function and the LCD will display "Feature Disabled." In order for the Hitch Recognition feature to function, the auto level sequence must be started with the front of the trailer above level.

System Settings

Homing Jacks

NOTE: When components are added or replaced the system will need to be homed.

1. Run the system by pressing "FRONT" (Fig. 1G). A special jack error code should occur. If not, introduce the special jack error code.

NOTE: To introduce an error, disconnect 1 of the hall effect sensor wires from the controller. After attempting to operate the disconnected jack, the touchpad screen will display an error. Reconnect the hall effect sensor wire.

NOTE: In order to clear the special jack error code the jacks need to be "homed." In order to "home" jacks, each jack must be able to retract a minimum of 6".

2. Extend all jacks to reach the 6" of minimum retract needed.
 - A. Press "FRONT" (Fig. 1G) to extend the front jacks (if required).
 - B. Press "REAR" (Fig. 1J) to extend the rear jacks (if required).
 - C. Press "LEFT" and "RIGHT" (Fig. 1H and Fig. 1I) simultaneously to extend the middle jacks (if equipped and required).
3. Press and hold the retract button until all of the jacks begin to retract. The jacks will retract until they reach the hard current limit.
4. The jacks are now "homed" and the special jack error code will be cleared.

NOTE: If the jacks do not retract, an error should display on the touch pad screen. This is typically caused by wiring interruption.

Zero Point Calibration

The "Zero Point" is the programmed point that the trailer will return to each time the Auto Level feature is used.

NOTE: Prior to starting this procedure, double check all connections on the controller, jacks, and touch pad.

1. In manual mode, run the jacks to level the trailer. This is best achieved by placing a level in the center of the trailer and leveling it both front to back and then side to side. (See "Basic Jack Operation" for instructions on how to manually operate the system).
2. Once the trailer is level, turn off the touch pad.
3. With the touch pad off, press and release the "FRONT" button (Fig. 1G) 5 times and then press and release the "REAR" button (Fig. 1J) 5 times.
4. The touch pad will flash and beep and the display will read "ZERO POINT CALIBRATION ENTER to set, Power to Exit" (Fig. 5).
5. To set the current position as the zero point, press the "ENTER" button (Fig. 1C).
6. LCD display will read "Zero point stability check" (Fig. 6).
7. LCD display will read "Zero point set successfully" once process is complete (Fig. 7).
8. The system will set this point as its level state and the touch pad will turn off.

Fig. 5



Fig. 6

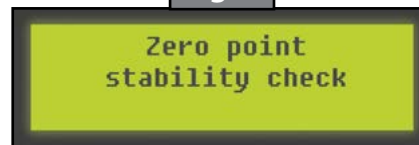
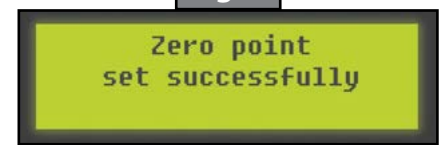

Fig. 7



Troubleshooting

⚠ WARNING

Ensure the trailer is supported at both the front and rear with jack stands before performing any troubleshooting or service to the trailer. Failure to do so may result in death or personal injury.

Manual Override

NOTE: For ease of manual override it is recommended to unplug the power harness to the motor prior to performing the manual override procedure.

NOTE: Use of a 12-18 volt cordless screw gun or pneumatic screw gun is acceptable to manually override the jacks. Do not use an impact screw gun to perform any of the override procedures, as this may damage the motor. If manual override is necessary there are two options.

Top of Jack Motor Override:

Tools needed: $\frac{3}{8}$ " drive ratchet and extension (no socket)

1. Find the port on the top of the jack motor (Fig. 8A).
2. Remove the rubber plug (Fig. 9A).
3. Insert the $\frac{3}{8}$ " drive into the port (Fig. 10).
4. Turn override until the jack extends or retracts to desired position.

Fig. 8

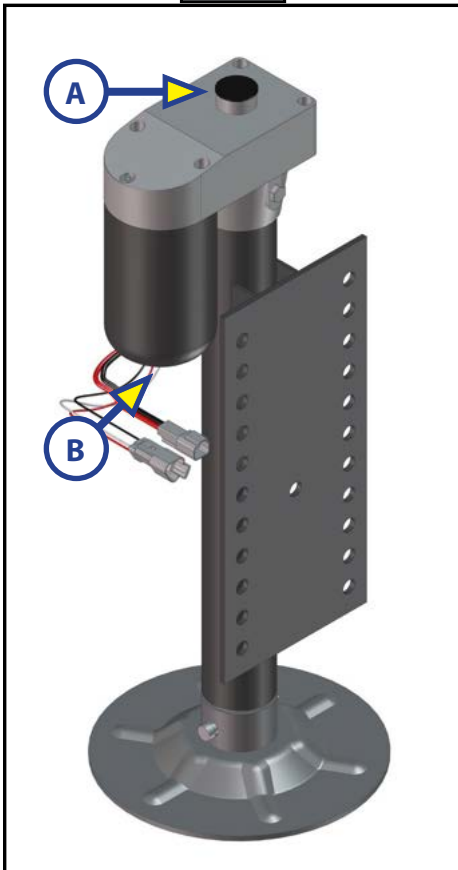

Fig. 9

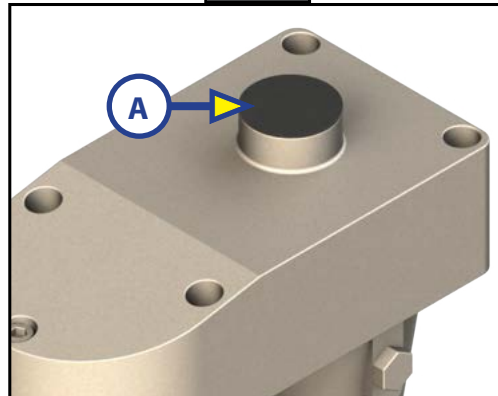

Fig. 10



Fig. 11

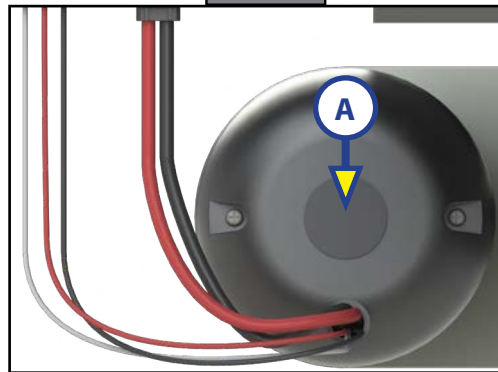

Fig. 12



Bottom of Jack Motor Override:

Tools needed: $\frac{3}{8}$ " drive ratchet and extension, $\frac{5}{16}$ " socket

1. Find the port on the bottom of the jack motor (Fig. 8B).
2. Remove the rubber plug (Fig. 11A).
3. Insert the $\frac{5}{16}$ " socket into the port (Fig. 12).
4. Turn override until the jack extends or retracts to desired position.

Touch Pad Error Codes

NOTE: To clear an error code from the touch pad, repair or otherwise correct the issue, then press "ENTER."
If the error is still present, the message will be displayed again.

LCD Message	What's Happening?	What Should Be Done?
****ERROR**** Excess Angle	Controller not properly secured.	Check and secure controller placement.
	Excessive angle reached during auto operation.	Relocate the trailer.
****ERROR**** Excessive Angle	Controller not properly secured.	Check and secure controller placement.
	Excessive angle reached during auto operation.	Relocate the trailer.
****ERROR**** Feature Disabled	Front of trailer below level when starting Auto Level process (only when trying to initiate Hitch Recognition).	Using manual mode on the touch pad, retract rear jacks (which includes the middle, if equipped) and set landing gear (front jacks) to hitch height.
	Touch pad power not cycled between consecutive leveling operations.	Turn touch pad off and then back on to reset the system.
	Zero point not set.	Set zero point.
****ERROR**** Low Voltage	Battery voltage dropped below 10.8V.	Check wiring - repair or replace.
		Test battery voltage under load - charge or replace.
****ERROR**** Out Of Stroke	Jack has reached maximum stroke length and is unable to lift.	Check disposition of jacks. Relocate the trailer.
	Unexpected high amp current stall.	Check jacks in manual mode or perform manual override procedure. Repair or replace as needed.
		Check for bent or damaged jacks. Repair or replace as needed.
****ERROR**** External Sensor	Bad connection or wiring from the controller to the rear sensor.	Replace or repair connection to rear remote sensor.
****ERROR**** Jack Time Out	Time limit exceeded for the requested auto operation.	Check disposition of jacks.
****ERROR**** Auto Level Fail	Unable to auto level due to uneven ground.	Check disposition of jacks. Relocate the trailer.
	Unable to auto level due to zero point being set incorrectly.	Reset zero point.
****ERROR**** Comm Error	Communication between controller and touch pad has been lost.	Check harness for proper connections or damage. Replace if necessary.
****ERROR**** Bad Calibration	Sensor calibration values are out of range.	Replace controller.
****ERROR**** Internal Sensor	Internal sensor problem.	Replace controller.
PANIC STOP Function Aborted	The user pressed a button on the touch pad during an automatic operation.	Restart automatic operation and then refrain from pressing any buttons on the touch pad.
****ERROR**** Hall Effect Short	Short circuit detected in one of the hall effect circuits.	Test for short and repair or replace.

Special Jack Error Codes

To clear 1 of the error codes listed below:

1. Correct or otherwise repair the issue (see the table below).

NOTE: In order to clear the special jack error code the jacks need to be "homed." In order to "home" jacks, each jack must be able to retract a minimum of 6".

2. Extend all jacks to reach the 6" of minimum retract needed.
 - A. Press "FRONT" (Fig. 1G) to extend the front jacks (if required).
 - B. Press "REAR" (Fig. 1J) to extend the rear jacks (if required).
 - C. Press "LEFT" and "RIGHT" (Fig. 1H and Fig. 1I) simultaneously to extend the middle jacks (if equipped and required).
3. Press and hold the retract button until all of the jacks begin to retract. The jacks will retract until they reach the hard current limit.
4. The jacks are now "homed" and the special jack error code will be cleared.

NOTE: If the jacks do not retract, an error should display on the touch pad screen. This is typically caused by wiring interruption.

LCD Message	What's Happening?	What Should Be Done?
ERROR	Error at a specific jack (left front, right front, left middle, right middle, left rear, right rear). Hall signal issue (open, short, malfunction or loss of communication); open or short circuit between controller and motor.	Check harness connections at controller and at jack.
LF Jack		Check harness for damage.
RF Jack		Check fuses at controller.
LM Jack		Repair or replace as necessary.
RM Jack		
LR Jack		
RR Jack		

Wiring Diagram - 4 Point

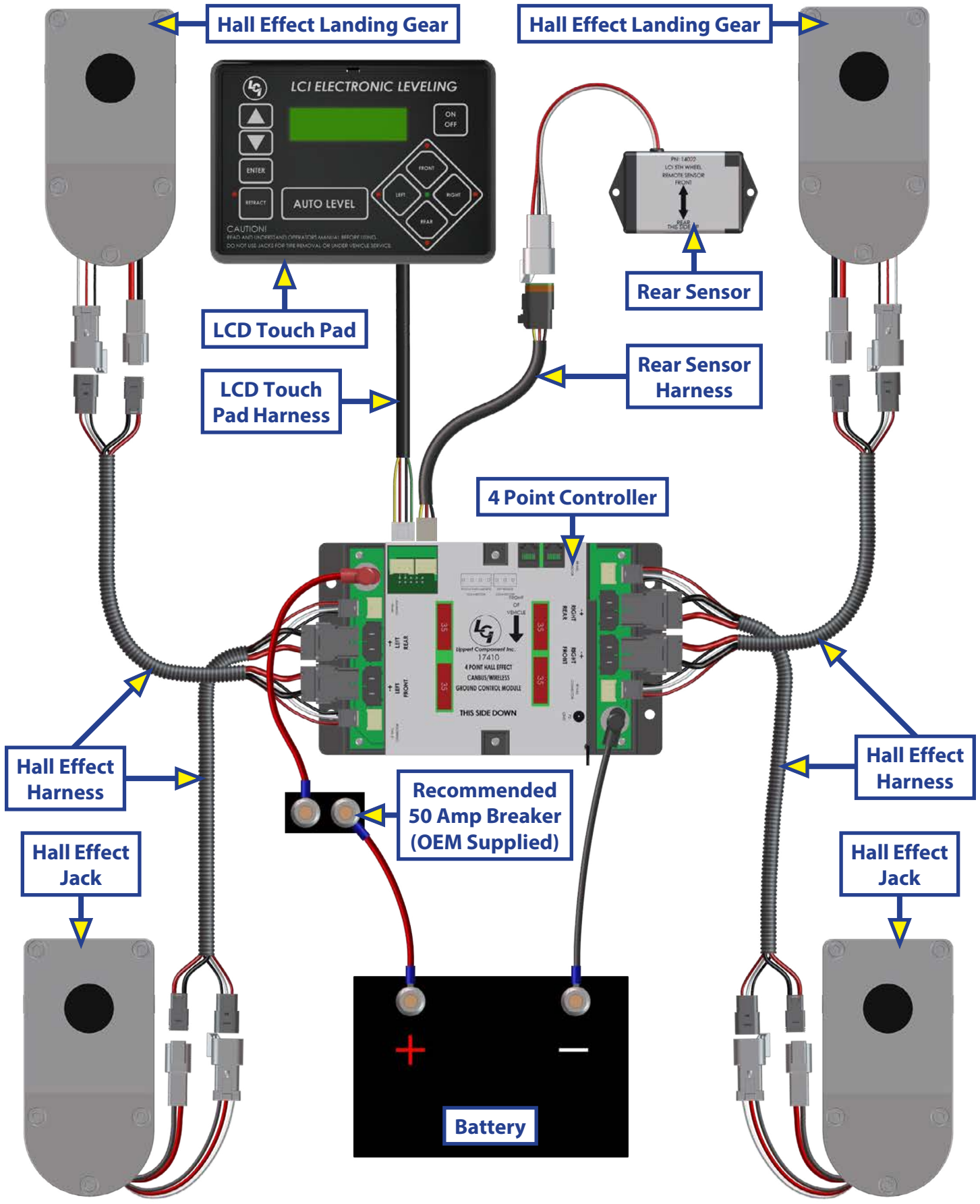

Wiring Diagram - 6 Point

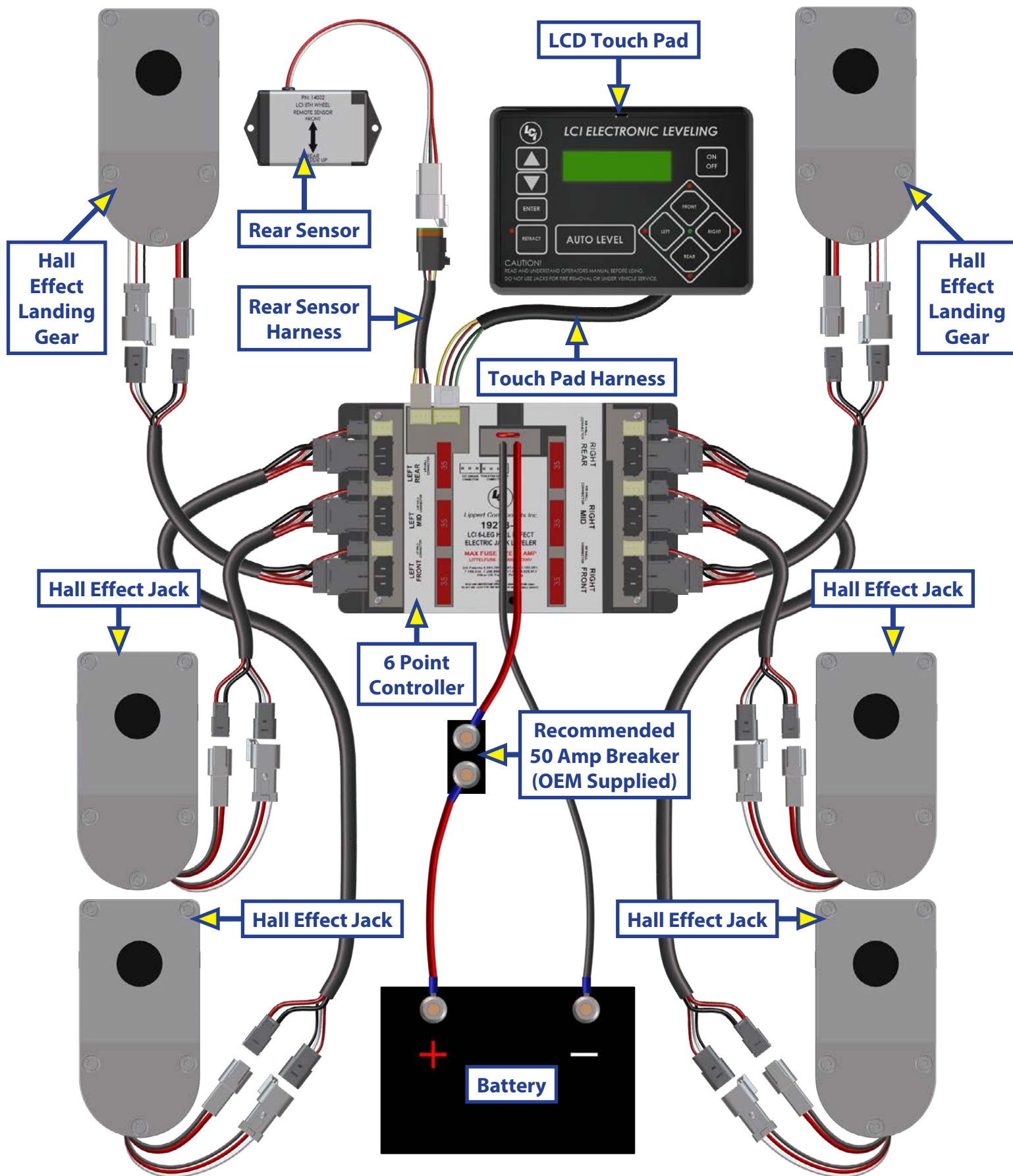



GROUND CONTROL® 3.0 4 POINT ASSEMBLY

LEVELING AND STABILIZATION

Hall Effect Jacks;
Left Rear

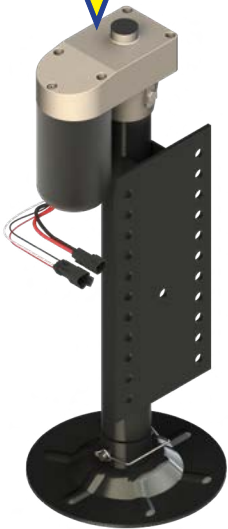

Hall Effect Jacks;
Right Rear



Jack Mounting
Bracket x2



Snapper Pin x2



Jack Mounting
Bolt & Nut x12



Bolt On
Pull Pin

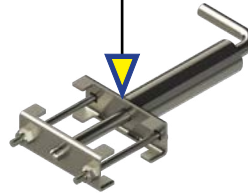

Carriage Bolt
& Lock Nut x4

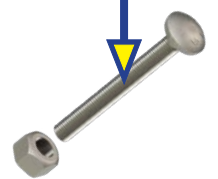

Landing
Gear x2

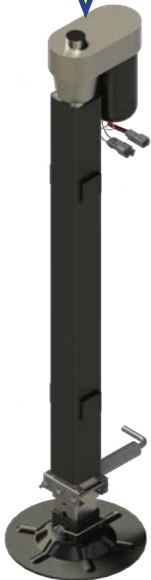

Landing Gear
Harnesses x2



Rear Jack
Harnesses x2



Power and
Ground
Harness

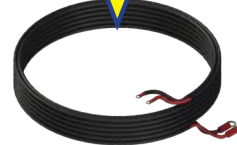

Rear Sensor
Screw x4



4 Point Controller



Control System



Rear Sensor
Mounting Plate



Rear Sensor & Harness

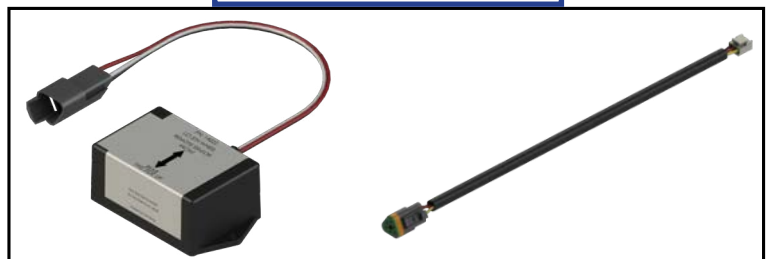

LEVELING AND STABILIZATION

Hall Effect Jacks;
Left Rear &
Middle x2

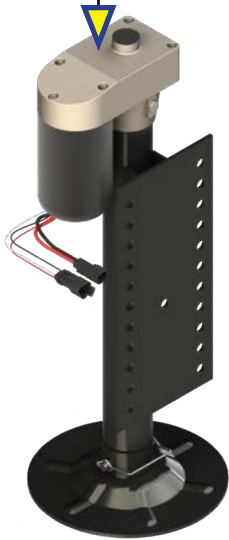

Hall Effect Jacks;
Right Rear &
Middle x2



Jack Mounting
Bracket x4



Snapper Pin x4



Jack Mounting
Bolt & Nut x24



Bolt On
Pull Pin

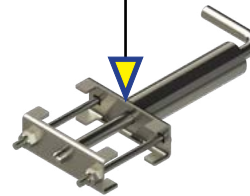

Carriage Bolt
& Lock Nut x4



Landing
Gear x2

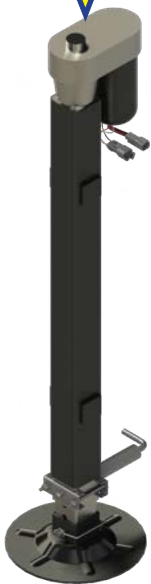

Landing Gear
Harnesses x2



Rear Jack
Harnesses x4

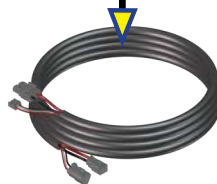

Power and
Ground
Harness

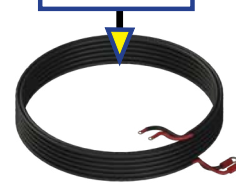

Rear Sensor
Screw x4



6 Point Controller



Control System



Rear Sensor
Mounting Plate



Rear Sensor & Harness

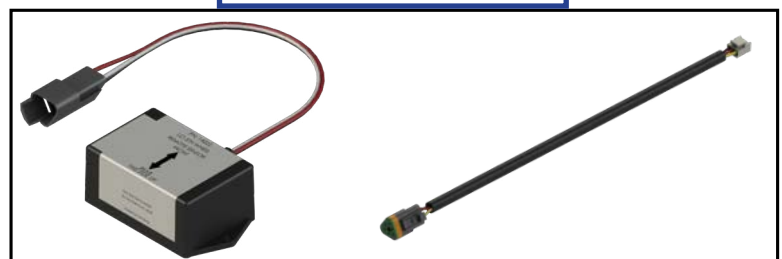



GROUND CONTROL® 3.0 4 POINT AFTERMARKET ASSEMBLY

LIPPERT COMPONENTS

LEVELING AND STABILIZATION

Hall Effect Jaks; Left Rear

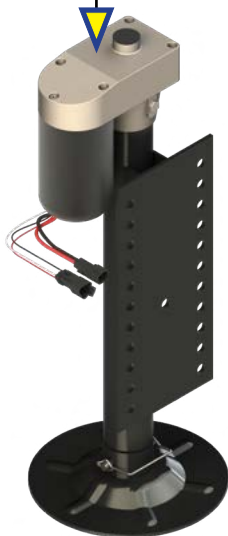

Hall Effect Jaks; Right Rear



Jack Mounting Bracket x2



Snapper Pin x2



Jack Mounting Bolt & Nut x12



Bolt On Pull Pin

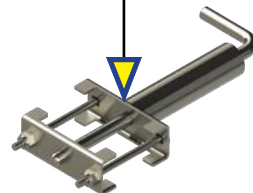

Carriage Bolt & Lock Nut x4

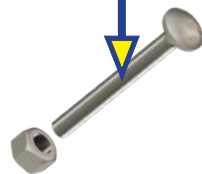

Landing Gear x2



Landing Gear Harnesses x2



Rear Jack Harnesses x2

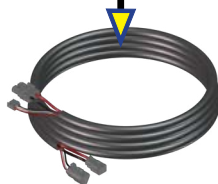

Power and Ground Harness



Rear Sensor Screw x4



4 Point Controller



Control System



Rear Sensor Mounting Plate



Rear Sensor & Harness





GROUND CONTROL® 3.0 6 POINT AFTERMARKET ASSEMBLY

LIPPERT COMPONENTS®

LEVELING AND STABILIZATION

Hall Effect Jacks;
Left Rear &
Middle x2

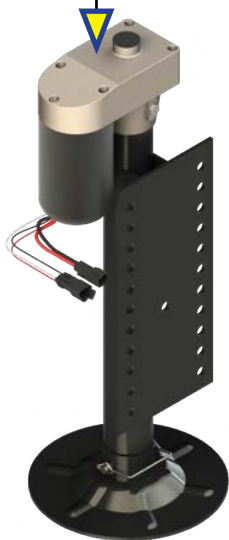

Hall Effect Jacks;
Right Rear &
Middle x2



Jack Mounting
Bracket x2



Snapper Pin x4



Jack Mounting
Bolt & Nut x24



Bolt On
Pull Pin

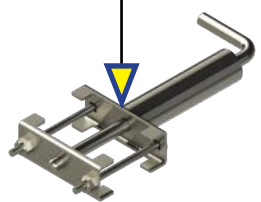

Carriage Bolt &
Lock Nut x4

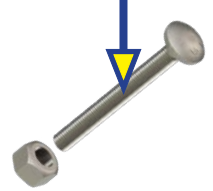

Landing
Gear x2



Landing Gear
Harnesses x2



Rear Jack
Harnesses x4



Power and
Ground
Harness

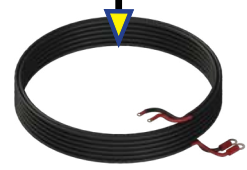

Rear Sensor
Screw x4



6 Point Controller



Control System

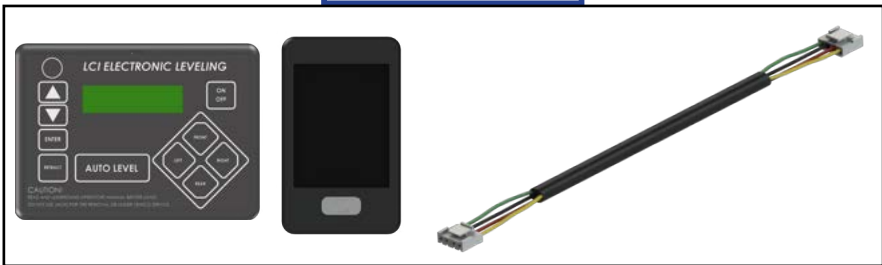

Rear Sensor
Mounting Plate



Rear Sensor & Harness

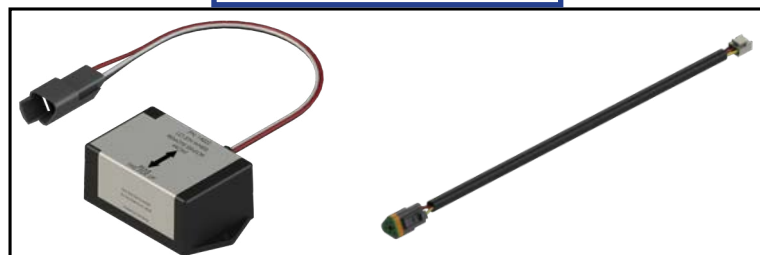

LEVELING AND STABILIZATION

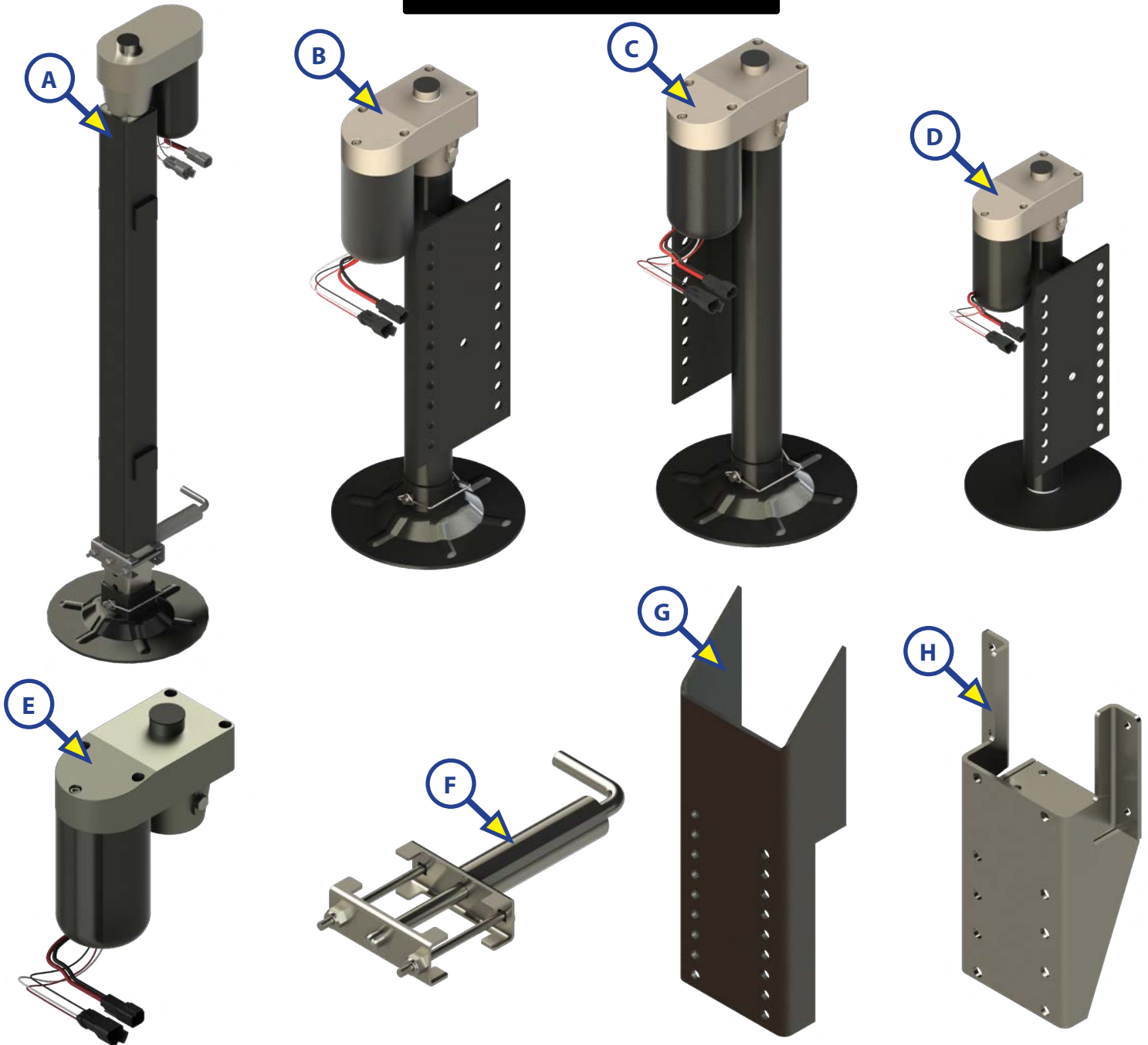

Callout	Part #	Description
A	305340	Hall Effect Landing Gear; Front Stroke 19.8125"
B	305339	Left Hall Effect Jack; Rear and Middle 12.5" Stroke
C	344792	Right Hall Effect Jack; Rear and Middle 12.5" Stroke
D	342610	Hall Effect Jack; Rear Short 10.5" Stroke
E	343758	Hall Effect Jack Motor
F	119113	Bolt On Pull Pin
G	134989	Weld On Jack Mounting Bracket (OEM Only)
H	349975	Bolt On Jack Mounting Bracket (Aftermarket Only)

LEVELING AND STABILIZATION

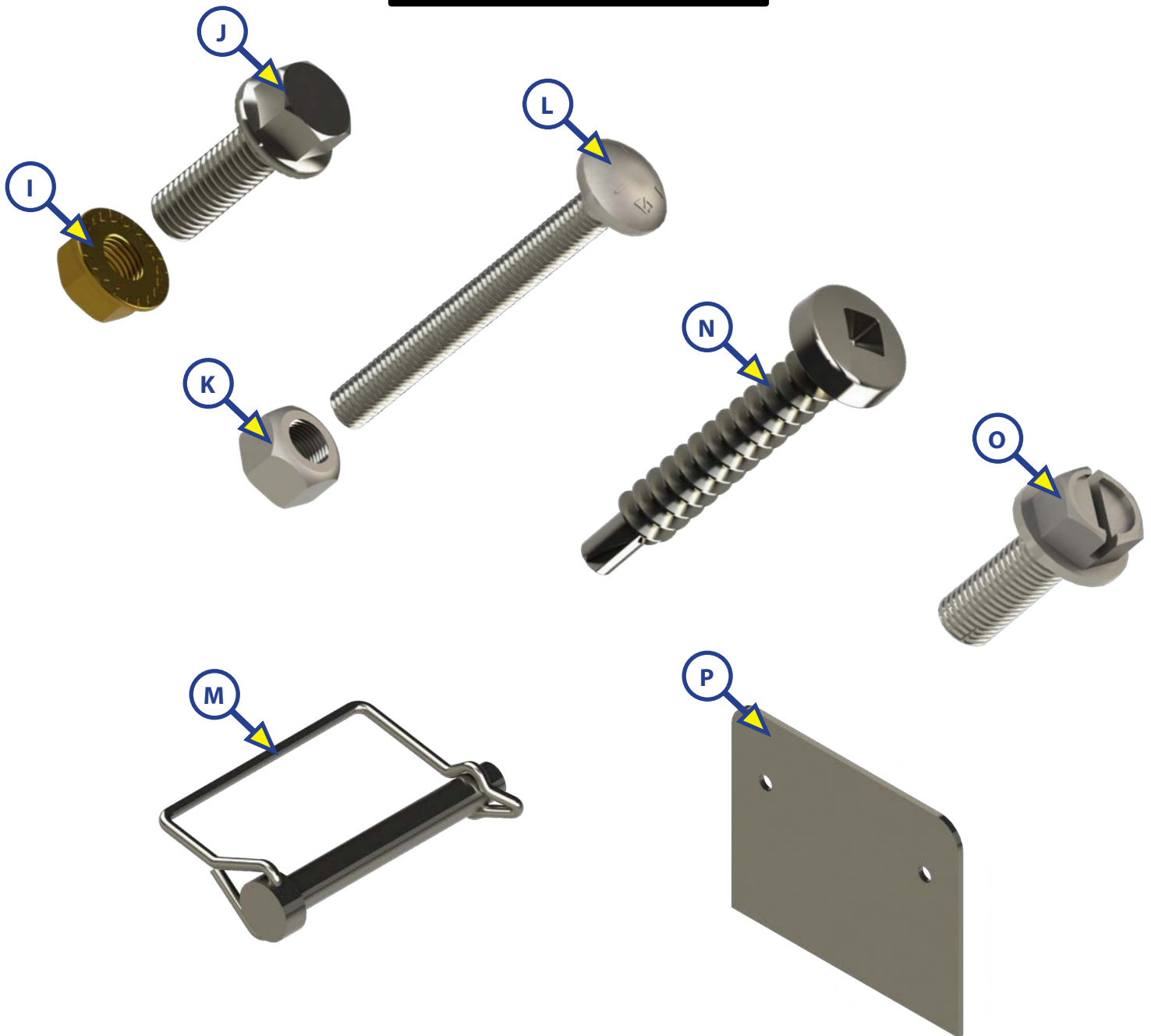

Callout	Part #	Description
I	178210	Jack Mounting Nut; 1/2" - 20
J	118076	Jack Mounting Bolt; 1/2" - 20 x 1 1/2" Flange
K	119073	Top Lock Nut
L	125878	Carriage Bolt
M	225598	Snapper Pin; 3/8 x 3"
N	241940	Rear Sensor Mounting Screw
O	191021	Hex Head Bolt (Aftermarket Only)
P	231775	Rear Sensor Mounting Plate

LEVELING AND STABILIZATION

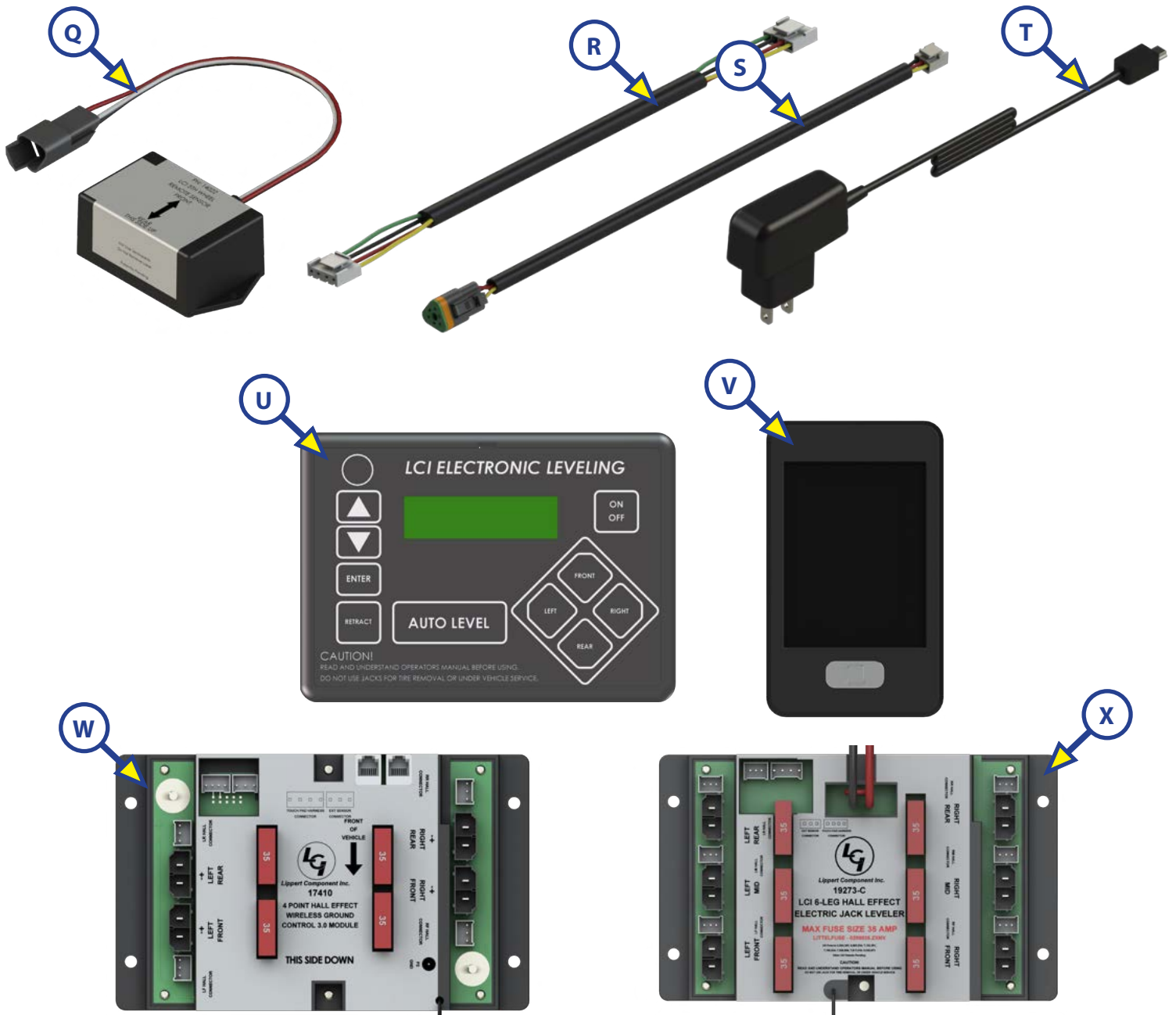

Callout	Part #	Description
Q	232201	Rear Sensor
R	232937	LCD Touch Pad Harness
S	243688	Rear Sensor Harness
T	267401	Linc Remote Charger
U	234802	LCD Touch Pad
V	329164	Linc Remote
W	304136	4 Point Hall Effect Canbus Wireless Ground Control Controller
X	346005	6 Point Hall Effect Canbus Wireless Ground Control Controller

LEVELING AND STABILIZATION

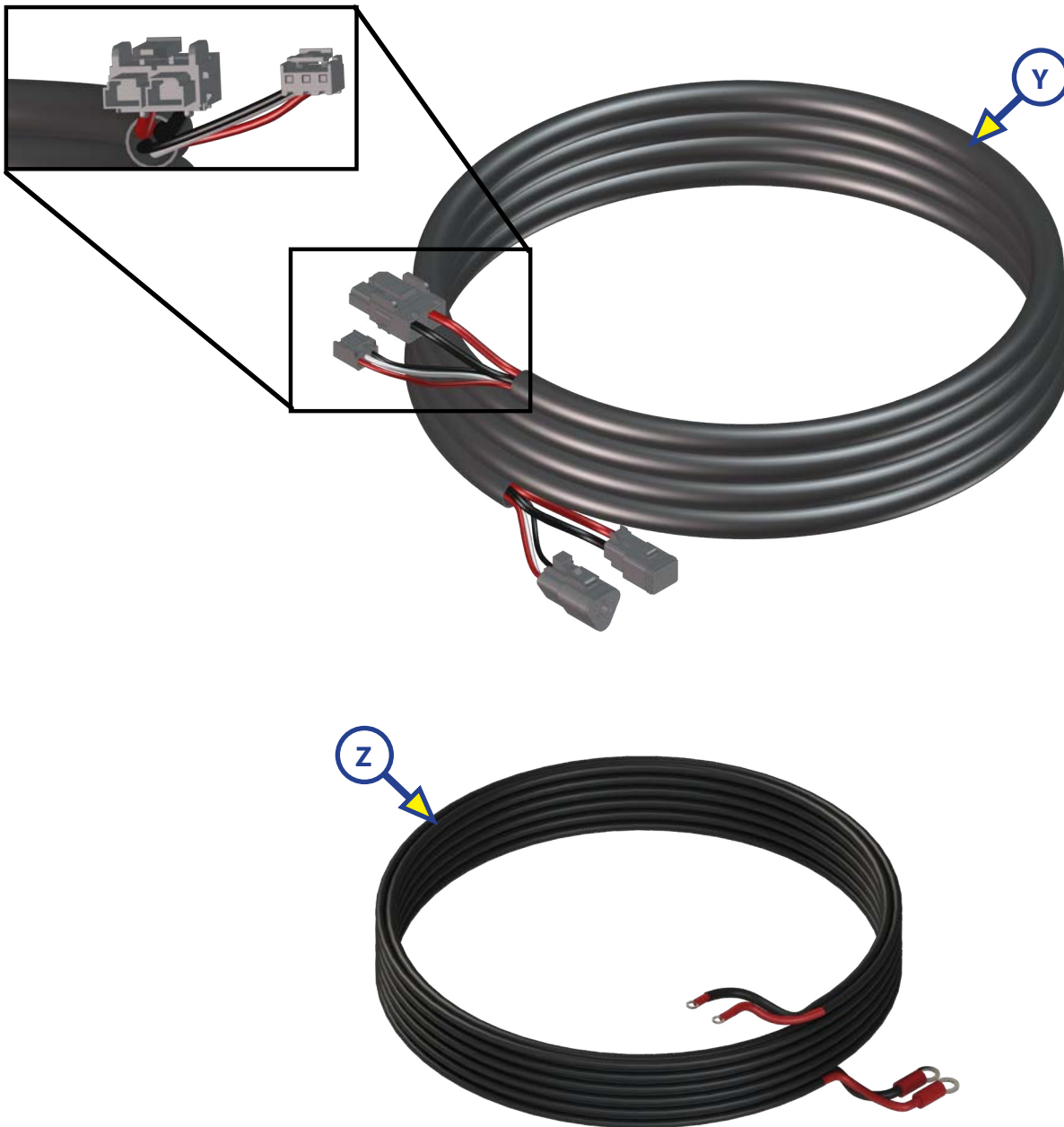

Callout	Part #	Description
Y	305115	Hall Effect Right Rear Sensor Harness
	306298	Hall Effect Left Rear Sensor Harness
	307489	Hall Effect Right Front Sensor Harness
	307490	Hall Effect Left Front Sensor Harness
	347012	Hall Effects Right Middle Sensor Harness
	347013	Hall Effects Left Middle Sensor Harness
Z	306176	Power and Ground Supply Harness



L I P P E R T C O M P O N E N T S[®]

The contents of this manual are proprietary and copyright protected by Lippert Components, Inc. ("LCI"). LCI prohibits the copying or dissemination of portions of this manual unless prior written consent from an authorized LCI representative has been provided. Any unauthorized use shall void any applicable warranty. The information contained in this manual is subject to change without notice and at the sole discretion of LCI.

Revised editions are available for free download from lci1.com.

Please recycle all obsolete materials.

For all concerns or questions, please contact
Lippert Components, Inc.

Ph: (574) 537-8900 | Web: lci1.com | Email: customerservice@lci1.com